

MoveLite WireFree RTS









Curtain Motor

The WireFree curtain motor solution offering all the essential features; suitable for all projects

PRODUCT MAIN FUNCTIONALITIES

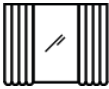

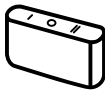
5
YEARS
WARRANTY

- **WireFree**
For simpler installation
- **Touch Motion**
- **Automatic & Adjustable end Limits**
- Manual Override**
Manual operation in case of power failure
- **Open, Close, Stop & My Position**
- **Compatible with 1-way and 2-way openings**
- **Compatible with Connexoon Window RTS** for App & voice control
- **Compatible with TaHoma switch** for App & voice control
- **Compatible with Glydea Track & Accessories**

COMPATIBLE END PRODUCTS



Curtain

BENEFITS FOR PROFESSIONALS

Reliable, robust and minimalistic

- A battery powered curtain motor solution with the essential functions
- Suitable for residential and commercial projects
- Curtain weight up to 35kg

Easy Installation

- The motor is battery operated; no wiring required
- Motor can be installed on the right or left side of the track

Convenience

- A removable battery pack makes it easy to recharge

PERFORMANCE

Somfy Technology	RTS
Curtain Maximum Weight	35kg
Nominal Torque (nm)	0.6
Linear Speed (cm/s)	15
Sound Level (dBA)	41
Voltage	14.8V
Radio Frequency (MHz)	433.42
Adjustable Limits	Yes
Touch Motion	Yes
Soft Start, Soft Stop	No
Max Track Length (m)	6 *
Compatible with Glydea Ultra Track & Curtain Accessories	Yes
Low Battery Indicator	LED & Beep
Battery Life	6 Months **
Charging Time	< 6 hours
WF Motor Item Number (includes li-ion battery & 3m White USB charging cable)	1241139
AU Plug Item Number	9028483 (Sold Separately)
Dedicated RTS Wall Mounts for Curtain	Smoove 1 Open/Close Black RTS [1811009] Smoove 1 Open/Close White RTS [1811011] [Frame not included; Frame sold separately]

* Compatible with straight and curved tracks

** Based on 35kg/4m straight, 2-way, 1 open and close per day.

BENEFITS FOR END USERS

Elegance and comfort

- An accessible battery powered curtain motor solution which provides just the essential features
- Discreet design
- No visible wiring

Easy use and maintenance

- Rechargeable battery (1 charge every 6 months)
- Low battery LED indicator

Smart and Simple

- Movelite WireFree RTS is compatible with Connexoon Window RTS & TaHoma switch for App control, and Google Assistant or Amazon Alexa for voice control

TECHNICAL DATA

Thermal Time	2.5 Mins
Supply	DC
Index Protection Rating	IP30
Limit Switch Unit	Electronic
Temperature Working Range	0°C to +60°C
Electric Insulation	Class III

DIMENSIONS

L1	298mm
L2	278mm
L3	93mm
L4	53mm

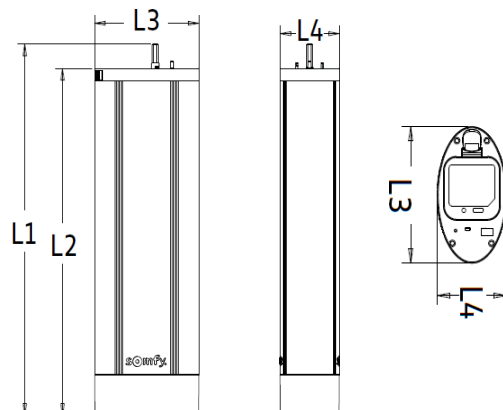

Compatible Curtain Accessories

Curtain Accessory	Silent Accessory White	Heavy Duty White	Heavy Duty Black
ROTATING EYE RUNNER			9026941
HIGH PERFORMING ROTATING RUNNER	1782921	1781415	9026932
RIPPLE RUNNER 1 7/8" (48mm)	9027594	1780901	
RIPPLE RUNNER 2 1/8" (54mm)	9027593	1780902	9026938
RIPPLE RUNNER 2 3/8" (60mm)	9027592	1780903	9026939
RIPPLE RUNNER W/EYELET 60MM	9027591	1782310	9028569
RIPPLE RUNNER W/EYELET 80MM	9027590		
RIPPLE FOLD RUNNER FIXING	9027657		
MASTER CARRIER	1782922	1781344	
DRIVE PULLEY ASSEMBLY		1780945	9026933
SMALL PULLEY ASSEMBLY		1782318	9026927
PULLEY ASSEMBLY		1780897	
PULLEY COVER		1780898	9026931
MOTOR HOOK		1780895	9026928
MOTOR HOOK WITH SNAP		1780905	9026940
SWIVEL CEILING BRACKET		1780906	9026929
ONE TOUCH CEILING BRACKET		1780907	9028544
ADJUSTABLE WALL MOUNT BRACKET		1780909	9026930
DOUBLE ADJUSTABLE WALL MOUNT BRACKET		1780910	
CEILING FIXING PLATE		1782789	
RIPPLE FOLD STRAIGHT ARM		1780946	9026936
RIPPLE OVERLAP ARM KIT		1780947	9026937
SMALL RIPPLE UNDERLAP ARM KIT		1782321	9026935
SMALL RIPPLE OVERLAP ARM KIT		1782320	

Compatible Curtain Accessories

Item Number	Description
9026571	CURTAIN RAIL 6.3M - WHITE
9026572	CURTAIN RAIL 6.3M - MILL FINISH
1782084	HIGH PERFORMANCE BELT - 60M
1781416	HEAVY DUTY STRAIGHT ARM
1781417	HEAVY DUTY OVERLAP ARM KIT
1782316	HEAVY DUTY RAIL JOINT
1782301	RIPPLE SNAP TAPE (4-1/4") 91.4M
1780953	HEAVY DUTY RIPPLE FOLD BUTT ARM KIT
1782319	ONE WAY BUTT ARM
9027045	ADJUSTABLE RIPPLE FOLD ARM
9027179	90 DEGREE MOTOR ADAPTOR
1780908	TOP MOUNT KIT
1782106	GLYDEA - GLYSTRO ADAPTER PLATE
1780954	PULLEY STOPPER ASSEMBLY
9015443	GLYDEA DCT DATA CABLE
9014599	DRY CONTACT SETTING TOOL (trade price only - no discounts apply)
1870275	GLYDEA ULTRA RS485 MODULE

For more information or to view the full range of Somfy Curtain motors and accessories, please refer to the Somfy Curtain Databook or contact your trusted Somfy Curtain partner.