

# Glydea™ Range

EXPANDING HORIZONS



**CATALOGUE 2010**

Motorization solution for curtains

## CONTENTS

Glydea™, your guarantee of added value in a demanding market	p. 4
Glydea™, the difference is in the detail	p. 6
Glydea™, everywhere flexibility is the rule	p. 8
Technical specification	p. 10
Ordering and pricing	p. 16
Part list	p. 22
Notes	p. 26

## Glydea™ broadens your horizons



Glydea™ curtain motorization solutions meet the requirements of the most prestigious projects. Motorized curtains are becoming a common feature of top-of-the-range projects such as high-quality hotels, luxury homes, meeting and conference venues. Glydea™ is discreet, flexible and robust, offering personalized solutions to serve your imagination and broaden your horizons.

## Glydea™, your guarantee of added value in a demanding market

With Glydea™ motorization solutions, make your venue stand out in terms of image, usage and functionality.

- Glydea™ improves the image of a venue and makes the job of service personnel easier.
- Glydea™ provides the level of comfort reliability that users and guests expect of venues of this type.
- The automated feature of Glydea™ motorization solutions contributes to energy savings and security (presence simulation).
- Glydea™ extends the lifespan of your curtains, avoiding the damage caused by manual operation.



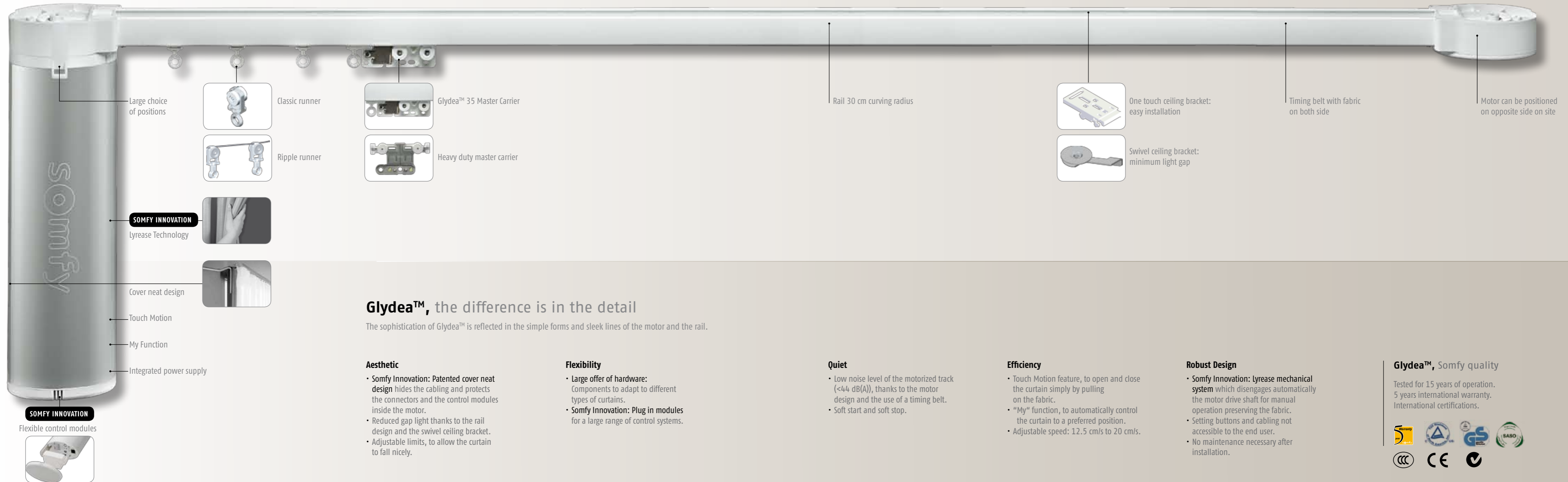

## Glydea™, the difference is in the detail

The sophistication of Glydea™ is reflected in the simple forms and sleek lines of the motor and the rail.

### Aesthetic

- Somfy Innovation: Patented cover neat design hides the cabling and protects the connectors and the control modules inside the motor.
- Reduced gap light thanks to the rail design and the swivel ceiling bracket.
- Adjustable limits, to allow the curtain to fall nicely.

### Flexibility

- Large offer of hardware: Components to adapt to different types of curtains.
- Somfy Innovation: Plug in modules for a large range of control systems.

### Quiet

- Low noise level of the motorized track (<44 dB(A)), thanks to the motor design and the use of a timing belt.
- Soft start and soft stop.

### Efficiency

- Touch Motion feature, to open and close the curtain simply by pulling on the fabric.
- "My" function, to automatically control the curtain to a preferred position.
- Adjustable speed: 12.5 cm/s to 20 cm/s.

### Robust Design

- Somfy Innovation: Lyrease mechanical system which disengages automatically the motor drive shaft for manual operation preserving the fabric.
- Setting buttons and cabling not accessible to the end user.
- No maintenance necessary after installation.

### Glydea™, Somfy quality

Tested for 15 years of operation.  
5 years international warranty.  
International certifications.



## Glydea™, everywhere flexibility is the rule

The flexibility of Glydea™ gives all the solutions to answer to the most demanding projects.

### Adaptability

- A large range of solutions, with only one rail, two types of motors, and several control modules.
- The offers can be personalized thanks to a large range of options.

### Universal



- Rail up to 15m long.
- Bending radius up to 30 cm.
- Large choice of rail shapes.
- Curtain weight up to 100 kg (tandem).
- Large range of accessories to adapt to different types of curtains.

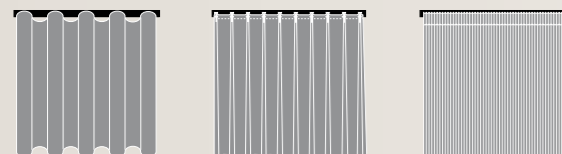

### Large offer for all curtain types and shapes

		LATERAL OPENING 	CENTRAL OPENING 	OTHER SHAPE TYPES 
<b>Glydea™ 35</b> 		35 kg / 10 m	35 kg / 10 m	
<b>Glydea™ 60e</b> 		60 kg / 10 m	60 kg / 10 m	
<b>Glydea™ 60e Tandem</b> 		100 kg / 15 m	100 kg / 15 m	

### Large choice of control systems



#### Standard compatibilities

- Hotel or Home Automation dry contact or AC switching relays.
- AC switches and control systems.
- Double or triple push button switches.
- Somfy or universal infrared transmitters.



#### Glydea™ can be equipped with plug in modules to interface with additional control technologies

RTS receivers,  
compatibility with all the Somfy RTS controls.



RS485 module,  
to interface with two-way home automation communication systems.



Tandem module,  
to link two Glydea™ 60e DCT on the same track, and reach up to 100kg curtain weight capacity.

### Easy installation

- From plug and play to more advanced solutions.
- Motor can be also hidden in false ceilings.
- Motor position (left or right) can be changed on site.
- Automatic or adjustable limit setting.
- One touch or swivel ceiling bracket.
- Integrated 24V power supply.

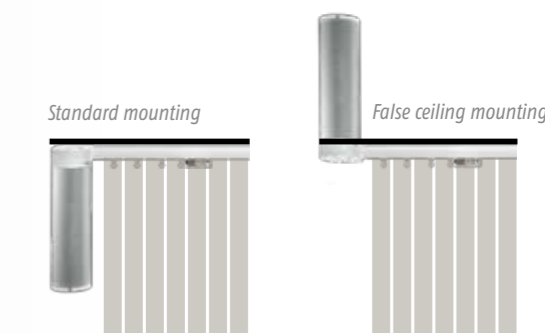

# Technical specifications

## Features overview

	Glydea™ 35 DCT	Glydea™ 35 WT <sup>(1)</sup>	Glydea™ 60e DCT	Glydea™ 60e WT <sup>(1)</sup>
<b>Motor unit main features</b>				
Soft start	•	•	•	•
Soft stop			•	•
Intermediate position			•	•
Manual operation	•	•	•	•
Touch motion			•	•
Automatic limits on end stop	•	•	•	•
Back release	•	•		•
Adjustable limits			•	
Speed control & adjustment			•	•
<b>Control options</b>				
AC switching		•		•
3 NO dry contacts	•		•	
2 NO dry contacts	•		•	
2 NO dry contact sequencing mode	•		•	
Dry contact individual and group & master control	•		•	
Infrared	•		•	
Tandem			•	
RS485 digital technology	•		•	
Radio Technology SOMFY	•	•	•	•
Sun control	•		•	
Timer control	•	•	•	•
<b>Installation and settings features</b>				
Setting with buttons on motor unit			•	•
Setting with external 3 no dry contact switch	•	•	•	•
LED indicators			•	•
Motor unit direction change	•	•	•	•
Factory reset	•	•	•	•
Upside down mounting	•	•	•	•
<b>Tracks / Curtain types</b>				
Lateral	•	•	•	•
Central	•	•	•	•
Asymmetric	•	•	•	•
Multiple	•	•	•	•
Classic (Pinch pleat)	•	•	•	•
Ripple drape with overlap arm	•	•	•	•
Ripple drape with butt arm	•	•	•	•

## Motorized track main characteristics

	Glydea™ 35 DCT	Glydea™ 35 WT <sup>(1)</sup>	Glydea™ 60e DCT	Glydea™ 60e WT <sup>(1)</sup>
Power supply	90 V to 250 V 50/60 HZ			
Average linear speed	20 cm/s		12.5 / 15 / 17 / 20 cm/s	
Power consumption	60 W		120 W	
Power cable type	3-wire cable	4-wire cable	3-wire cable	4-wire cable
Control connector type	RJ12		RJ12	
DCT Control circuit voltage	3.3 VDC	90 V to 250 V AC	3.3 VDC	90 V to 250 V AC
Motorized track noise level <sup>(2)</sup>	50 dB(A)		44 dB(A) <sup>(3)</sup>	
Certifications	c TUV us, CCC, CE			
Track maximum length	15 m			
Maximum number of junctions	2			
Minimum bending radius	30 cm			
Minimum curving radius	3 m			

<sup>(1)</sup> WT motors can be switched to DCT mode by connecting both direction wires to live.

<sup>(2)</sup> Sound pressure level according to Somfy measurement standard.

<sup>(3)</sup> At 15 cm/s.

## Motor dimensions

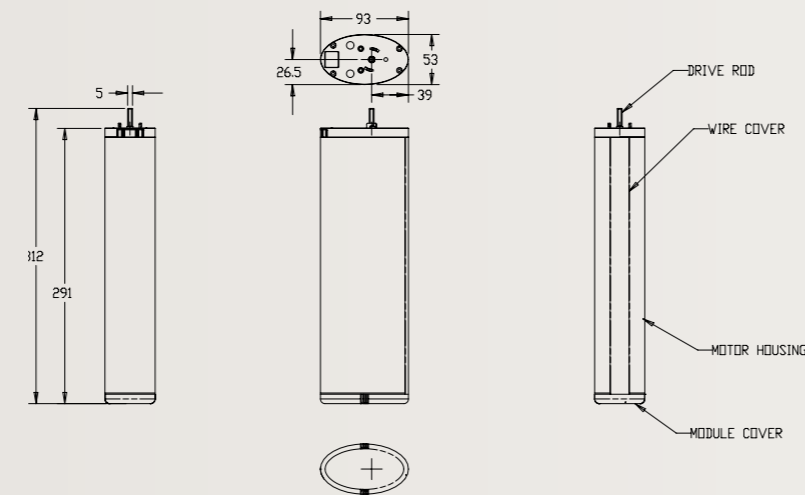

## Glydea™ motorized track dimensions

### 1 RAIL AND MOTOR: GLYDEA™ 35 CLASSIC

#### Lateral opening (one way) equipped with flexible master carrier

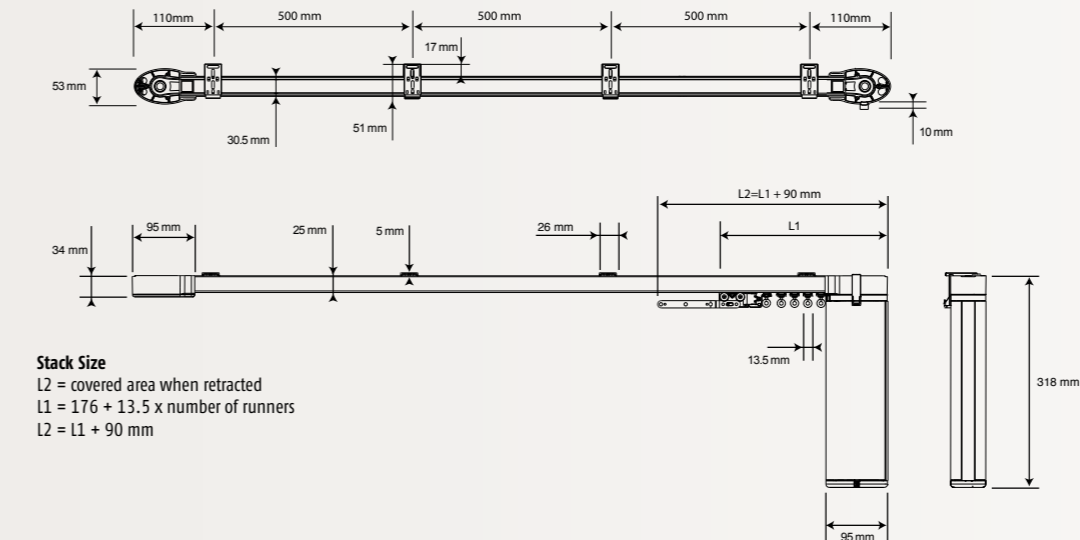

#### Stack Size

L2 = covered area when retracted  
L1 = 176 + 13.5 x number of runners  
L2 = L1 + 90 mm

#### Central opening (two way) equipped with flexible master carrier

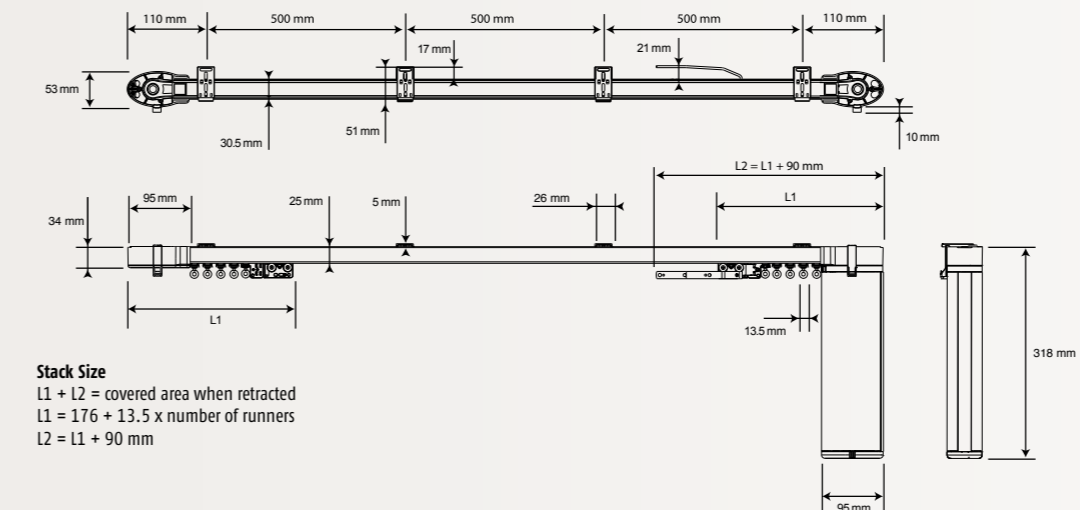

#### Stack Size

L1 + L2 = covered area when retracted  
L1 = 176 + 13.5 x number of runners  
L2 = L1 + 90 mm

#### One touch ceiling bracket

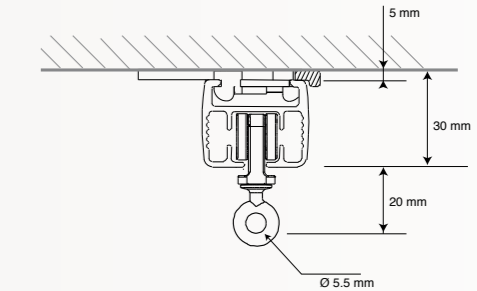

#### Swivel ceiling bracket

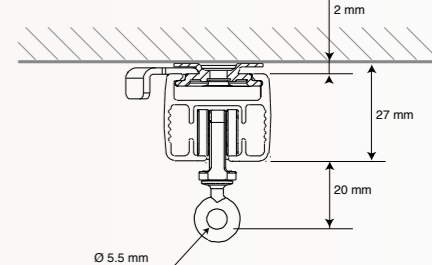

## 2 RAIL AND MOTOR: GLYDEA™ 60E CLASSIC

### Lateral opening (one way) equipped with heavy duty master carrier

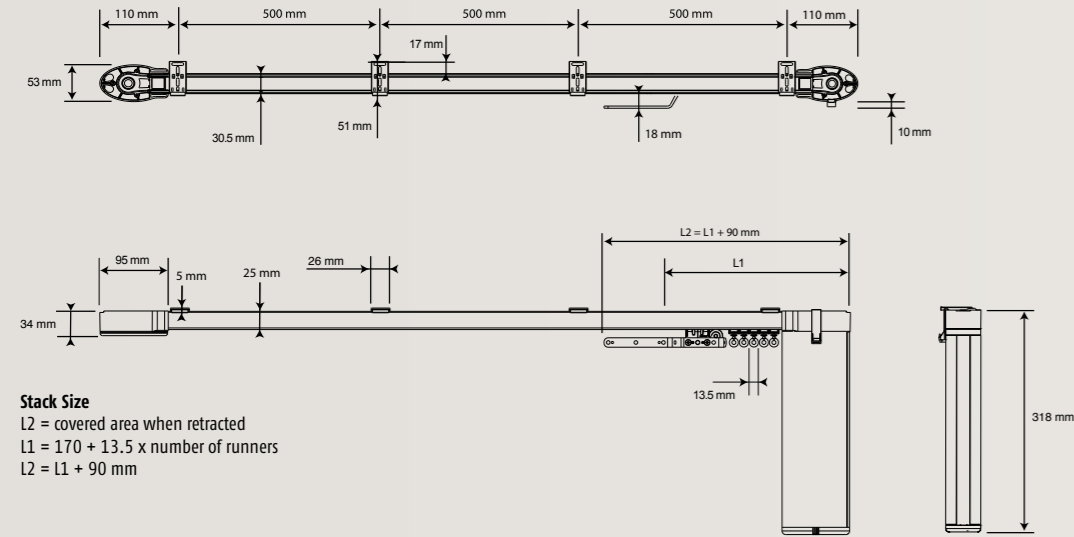

### One touch ceiling bracket

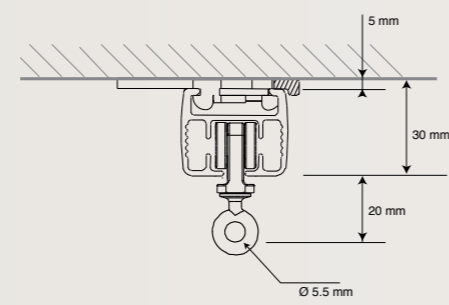

### Central opening (two way) equipped with heavy duty master carrier

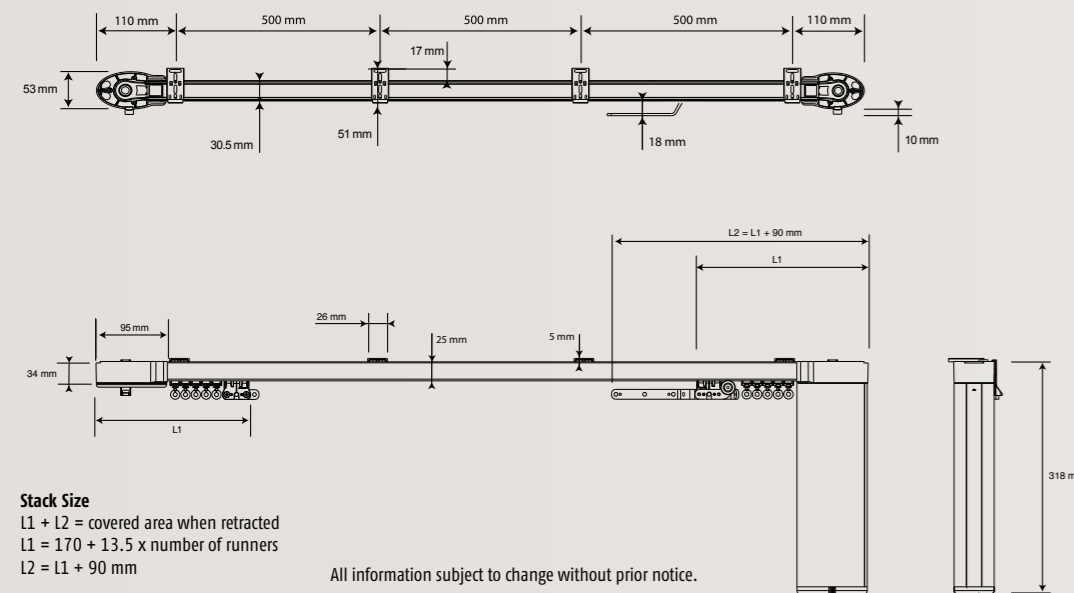

### Swivel ceiling bracket

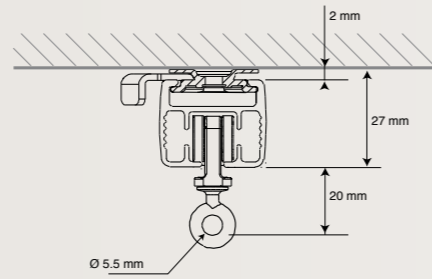

All information subject to change without prior notice.

## 3 RAIL AND MOTOR FOR "RIPPLE" CURTAIN

### Lateral opening (one way)

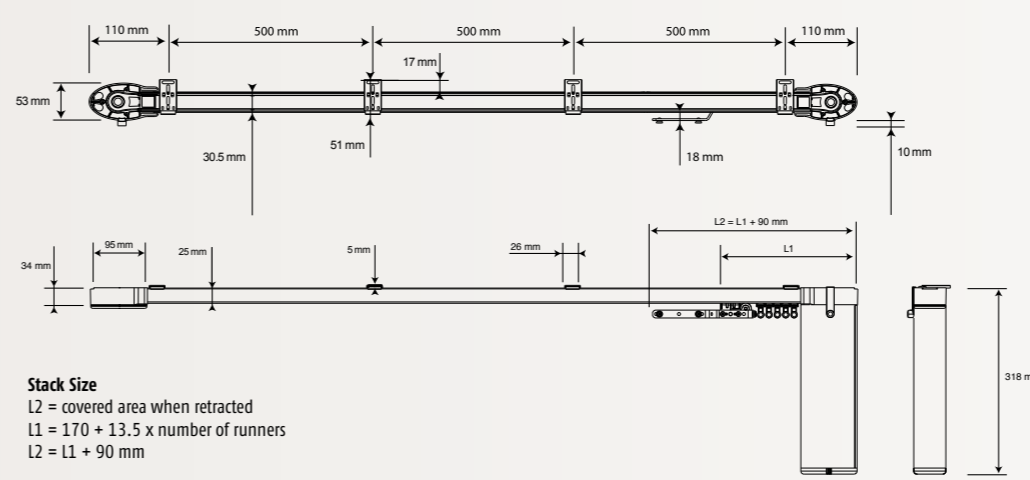

**Stack Size**  
L2 = covered area when retracted  
L1 = 170 + 13.5 x number of runners  
L2 = L1 + 90 mm

### Central opening with buttarms

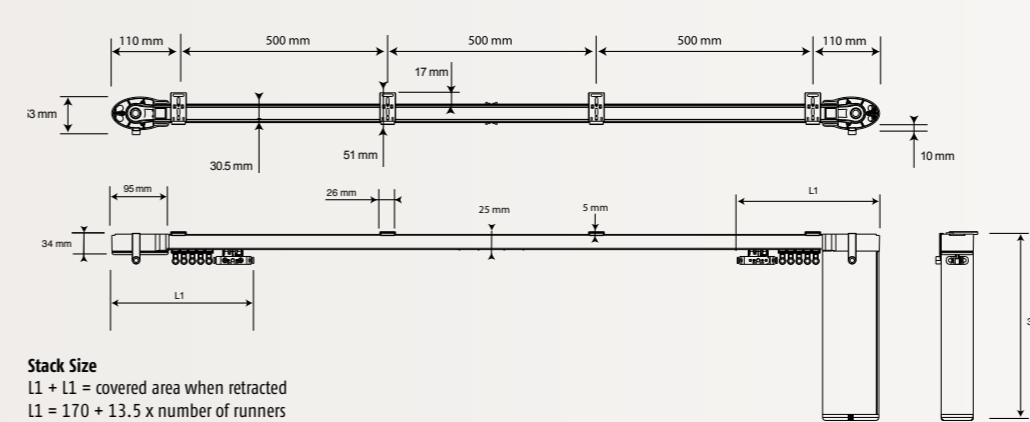

**Stack Size**  
L1 + L1 = covered area when retracted  
L1 = 170 + 13.5 x number of runners

### Central opening (two way)

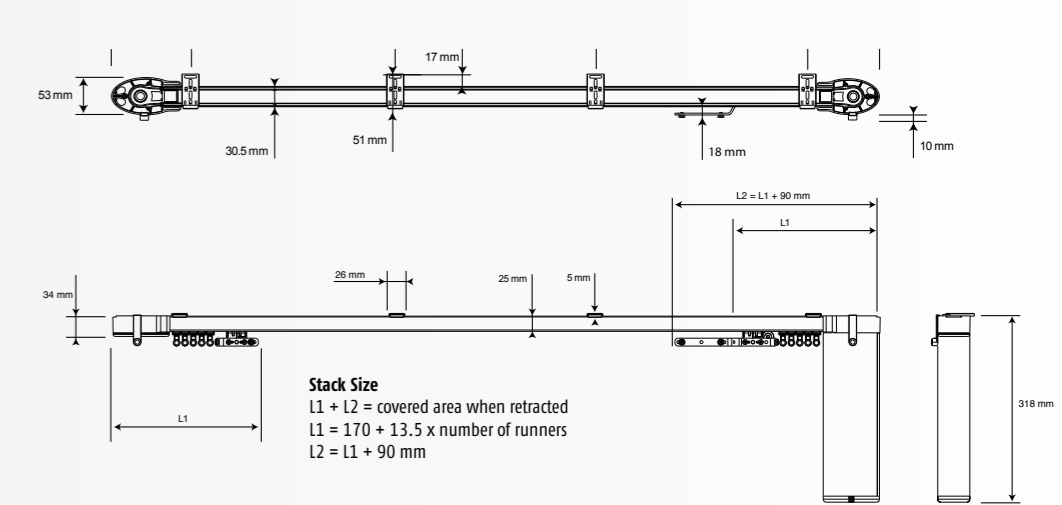

**Stack Size**  
L1 + L2 = covered area when retracted  
L1 = 170 + 13.5 x number of runners  
L2 = L1 + 90 mm

#### 4 BRACKETS TYPES AND DIMENSIONS

##### One touch ceiling bracket

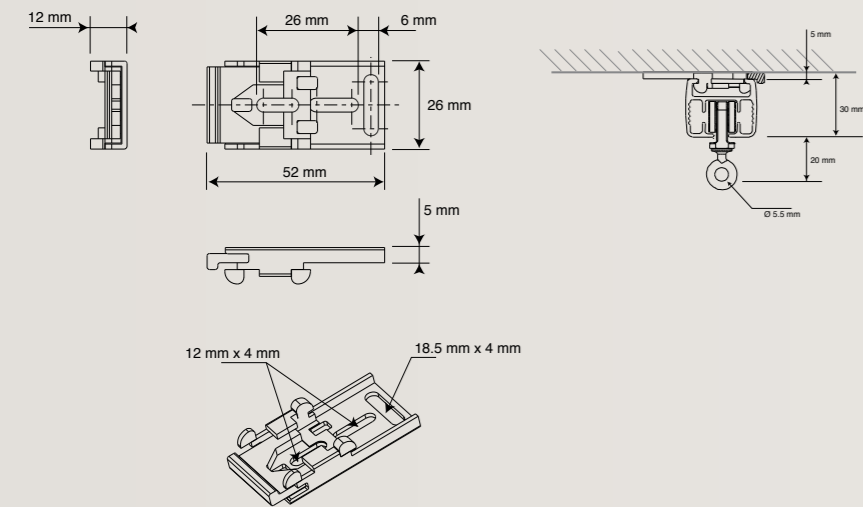

##### Adjustable wall mount bracket

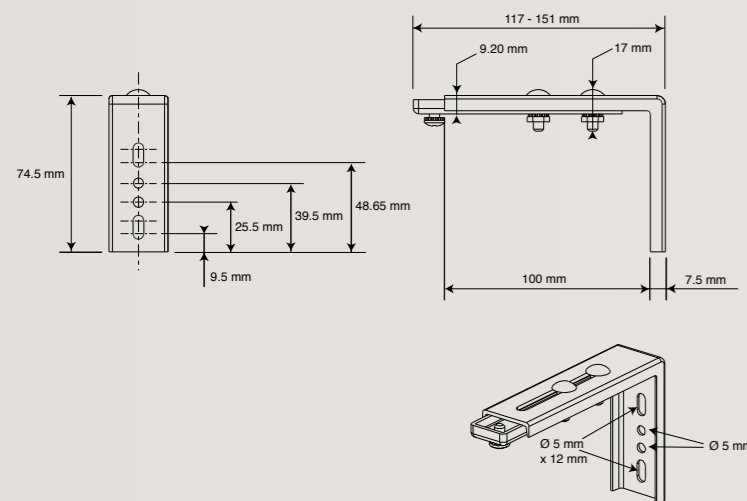

##### Swivel ceiling bracket

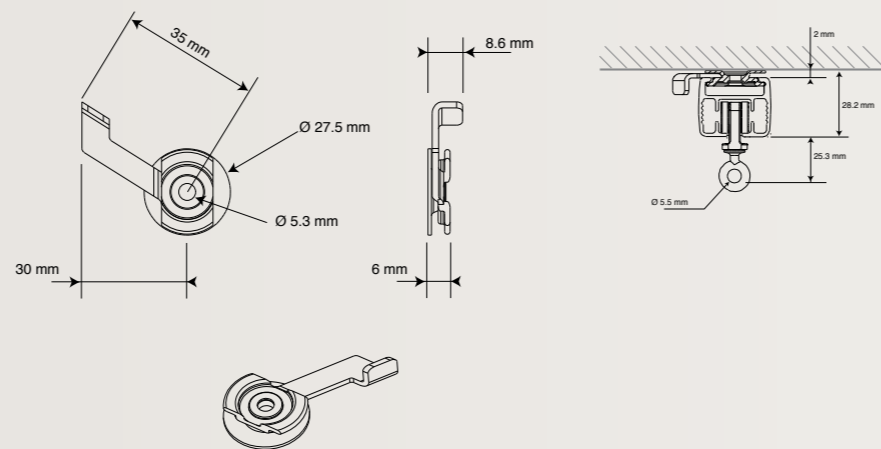

##### Double adjustable wall mount bracket

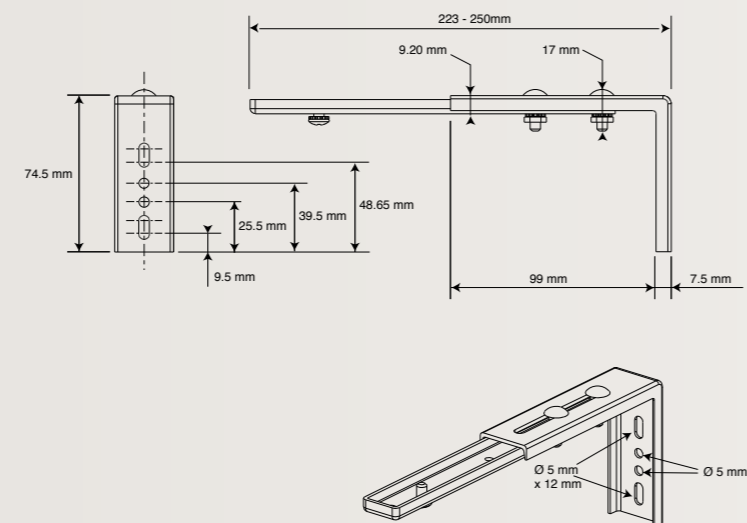

#### Motor load capacity according to track opening, shape, length

In the charts below we give the maximum weight of curtain in kg, which has to be motorized by the different Glydea™ versions according to the different track configurations, and the length of the track.

When calculating the weight of the curtain the fullness ratio of the curtain has to be taken:

$$\text{Weight of the curtain} = \text{fabric weight/m}^2 \times \text{Curtain covered area} \times \text{fullness ratio}$$

The traversing capacity is given for an installation with no extra friction created by the fabric curtain touching the rail or the track pelmet.

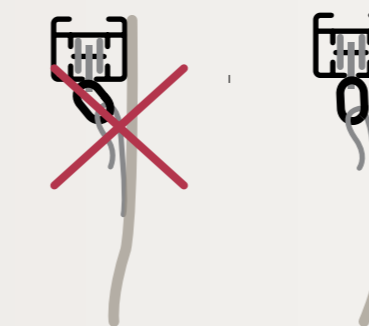

#### Track bending and curving minimum radius

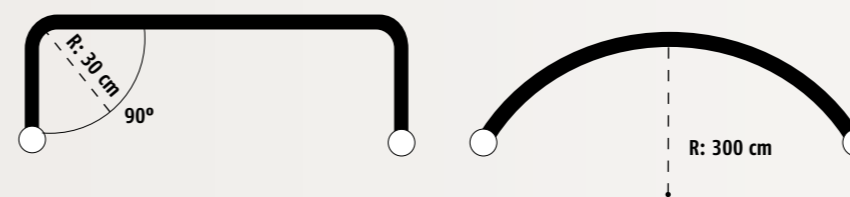

- For bending and curving tracks length and radius limitation please refer to the specific data sheet.
- Maximum weight per runner: 1.5 kg.
- Maximum distance between runners: 10 mm.

#### Traversing capacity for "Classic" and "Ripplefold" curtain

Track type	Glydea™ 35			Glydea™ 60e			Glydea™ 60e Tandem		
	3m	6m	10m	6m	10m	15m	6m	10m	15m
A	35*	35*	35	60	60				
B	35*	35*	35	60	60				100
C	35*	35*		35					
D	35*	15*		35					
E	15			35					
F	15			35	30				50
G	35								
H	15								

\*Capacity limit for Master Carrier GA 35.

All information subject to change without prior notice.



# Ordering and pricing

## Step 1: Select track

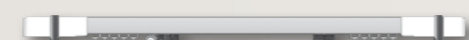

### 1 CLASSIC TRACKS



Track length (m)	One way classic ref.	Price
0.5 - 1.0	1 781 804	
1.0 - 1.5	1 781 283	
1.5 - 2.0	1 781 284	
2.0 - 2.5	1 781 285	
2.5 - 3.0	1 781 286	
3.0 - 3.5	1 781 287	
3.5 - 4.0	1 781 288	
4.0 - 4.5	1 781 289	
4.5 - 5.0	1 781 290	
5.0 - 5.5	1 781 291	
5.5 - 6.0	1 781 292	
6.0 - 6.5	1 781 293	
6.5 - 7.0	1 781 294	
7.0 - 7.5	1 781 295	
7.5 - 8.0	1 781 296	
8.0 - 8.5	1 781 297	
8.5 - 9.0	1 781 298	
9.0 - 9.5	1 781 299	
9.5 - 10	1 781 300	
10 - 10.5	1 781 301	
10.5 - 11	1 781 302	
11 - 11.5	1 781 303	
11.5 - 12	1 781 304	
12 - 12.5	1 781 305	
12.5 - 13	1 781 306	
13 - 13.5	1 781 307	
13.5 - 14	1 781 308	
14 - 14.5	1 781 309	
14.5 - 15	1 781 310	

Track length (m)	Two way classic ref.	Price
0.5 - 1.0	1 781 806	
1.0 - 1.5	1 781 311	
1.5 - 2.0	1 781 312	
2.0 - 2.5	1 781 313	
2.5 - 3.0	1 781 314	
3.0 - 3.5	1 781 315	
3.5 - 4.0	1 781 316	
4.0 - 4.5	1 781 317	
4.5 - 5.0	1 781 318	
5.0 - 5.5	1 781 319	
5.5 - 6.0	1 781 320	
6.0 - 6.5	1 781 321	
6.5 - 7.0	1 781 322	
7.0 - 7.5	1 781 323	
7.5 - 8.0	1 781 324	
8.0 - 8.5	1 781 325	
8.5 - 9.0	1 781 326	
9.0 - 9.5	1 781 327	
9.5 - 10	1 781 328	
10 - 10.5	1 781 329	
10.5 - 11	1 781 330	
11 - 11.5	1 781 331	
11.5 - 12	1 781 332	
12 - 12.5	1 781 333	
12.5 - 13	1 781 334	
13 - 13.5	1 781 335	
13.5 - 14	1 781 336	
14 - 14.5	1 781 337	
14.5 - 15	1 781 338	

### Surcharges: bends and curves

Designation and track shapes (Unit =1)	Reference	Price
Bending of Glydea rail 	9 015 717	
Curving of Glydea rail 	9 015 718	
Packaging for bent track	9 015 719	

### Components included

- 1 runner per every 10 cm
- 1 hook for one way track
- 2 hooks for two way track
- Arms as shown
- 1 rail joint for rail over 5140 mm
- 2 rails joints for railover 10140 mm

All information subject to change without prior notice.

### 2 RIPPLE CURTAIN TRACKS: 54 MM (2 1/8") PITCH

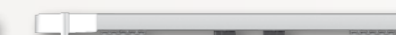
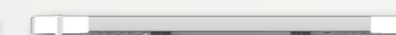
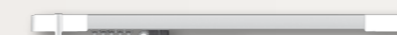



Track length (m)	One way ripple ref.	Price
0.5 - 1.0	1 781 807	
1.0 - 1.5	1 781 808	
1.5 - 2.0	1 781 809	
2.0 - 2.5	1 781 810	
2.5 - 3.0	1 781 811	
3.0 - 3.5	1 781 812	
3.5 - 4.0	1 781 813	
4.0 - 4.5	1 781 814	
4.5 - 5.0	1 781 815	
5.0 - 5.5	1 781 816	
5.5 - 6.0	1 781 817	
6.0 - 6.5	1 781 818	
6.5 - 7.0	1 781 819	
7.0 - 7.5	1 781 820	
7.5 - 8.0	1 781 821	
8.0 - 8.5	1 781 822	
8.5 - 9.0	1 781 823	
9.0 - 9.5	1 781 824	
9.5 - 10	1 781 825	
10 - 10.5	1 781 826	
10.5 - 11	1 781 827	
11 - 11.5	1 781 828	
11.5 - 12	1 781 829	
12 - 12.5	1 781 830	
12.5 - 13	1 781 831	
13 - 13.5	1 781 832	
13.5 - 14	1 781 833	
14 - 14.5	1 781 834	
14.5 - 15	1 781 835	

Track length (m)	Two way ripple ref.	Price
0.5 - 1.0	1 781 836	
1.0 - 1.5	1 781 837	
1.5 - 2.0	1 781 838	
2.0 - 2.5	1 781 839	
2.5 - 3.0	1 781 840	
3.0 - 3.5	1 781 841	
3.5 - 4.0	1 781 842	
4.0 - 4.5	1 781 843	
4.5 - 5.0	1 781 844	
5.0 - 5.5	1 781 845	
5.5 - 6.0	1 781 846	
6.0 - 6.5	1 781 847	
6.5 - 7.0	1 781 848	
7.0 - 7.5	1 781 849	
7.5 - 8.0	1 781 850	
8.0 - 8.5	1 781 851	
8.5 - 9.0	1 781 852	
9.0 - 9.5	1 781 853	
9.5 - 10	1 781 854	
10 - 10.5	1 781 855	
10.5 - 11	1 781 856	
11 - 11.5	1 781 857	
11.5 - 12	1 781 858	
12 - 12.5	1 781 859	
12.5 - 13	1 781 860	
13 - 13.5	1 781 861	
13.5 - 14	1 781 862	
14 - 14.5	1 781 863	
14.5 - 15	1 781 864	

Track length (m)	Two way ripple w/butt ref.	Price
0.5 - 1.0	1 781 865	
1.0 - 1.5	1 781 866	
1.5 - 2.0	1 781 867	
2.0 - 2.5	1 781 868	
2.5 - 3.0	1 781 869	
3.0 - 3.5	1 781 870	
3.5 - 4.0	1 781 871	
4.0 - 4.5	1 781 872	
4.5 - 5.0	1 781 873	
5.0 - 5.5	1 781 874	
5.5 - 6.0	1 781 875	
6.0 - 6.5	1 781 876	
6.5 - 7.0	1 781 877	
7.0 - 7.5	1 781 878	
7.5 - 8.0	1 781 879	
8.0 - 8.5	1 781 880	
8.5 - 9.0	1 781 881	
9.0 - 9.5	1 781 882	
9.5 - 10	1 781 883	
10 - 10.5	1 781 884	
10.5 - 11	1 781 885	
11 - 11.5	1 781 886	
11.5 - 12	1 781 887	
12 - 12.5	1 781 888	
12.5 - 13	1 781 889	
13 - 13.5	1 781 890	
13.5 - 14	1 781 891	
14 - 14.5	1 781 892	
14.5 - 15	1 781 893	

### Surcharges: bends and curves

Designation and track shapes (Unit =1)	Reference	Price
Bending of Glydea rail 	9 015 717	
Curving of Glydea rail 	9 015 718	
Packaging for bent track	9 015 719	

### Components included

- 1 runner per every 54 mm of track
- 1 hook for one way track
- 2 hooks for two way track
- Arms as shown
- 1 rail joint for rail over 5140 mm
- 2 rails joints for railover 10140 mm

All information subject to change without prior notice.

## Step 2: Select motors

Motors		Ref.	Price
	Glydea™ 35 DCT EU 1.5M: Dry contact and IR control, 3 wire 1.5M cable Unit 1	1 001 261	
	Glydea™ 35 WT EU 1.5M: AC switching control, 4 wire 1.5M cable Unit 1	1 001 525	
	Glydea™ 35 RTS 433 EU 1.5M: Dry contact and IR and RTS control, 3 wire 1.5M cable Unit 1	1 001 263	
	Glydea™ 60e DCT EU 1.5M: Dry contact and IR control, 3 wire 1.5M cable Unit 1	1 001 265	
	Glydea™ 60e WT EU 1.5M: AC switching control, 4 wire 1.5M cable Unit 1	1 001 537	
	Glydea™ 60e RTS 433 EU 1.5M: Dry contact and IR and RTS control, 3 wire 1.5M cable Unit 1	1 001 264	

## Step 3: select brackets

Swivel ceiling bracket	
	To minimize the light gap (max 2mm)
	Minimum quantity necessary:
	2,5/m of track
	Steel zinc plated
	Unit: 1
	Ref. 1 780 906
	Price:

Adjustable wall bracket	
	Used with either ceiling bracket
	Minimum quantity necessary:
	2,5/m of track
	Steel, white color
	Unit: 1
	Ref. 1 780 909
	Price:

One touch ceiling bracket	
	For an easy installation
	Minimum quantity necessary:
	2,5/m of track
	Steel, white color
	Unit: 1
	Ref. 1 780 907
	Price:

Double adjustable wall bracket	
	Used with either ceiling bracket
	Minimum quantity necessary:
	2,5/m of track
	Steel, white color
	Unit: 1
	Ref. 1 780 910
	Price:

## Step 4: Select optional hardware

Additional motor hook GA for classic curtain	
	Unit: 1
	Ref. 1 780 895
	Price:

Additional motor hook for ripple curtain	
	Unit: 1
	Ref. 1 780 905
	Price:

Additional rotating eye runner for classic curtain	
	Unit: 1
	Ref. 1 780 892
	Price:

Additional high performance runner	
	Unit: 1
	Ref. 1 781 415
	Price:

All information subject to change without prior notice.

## Step 5: Select controls

### 1 GLYDEA™ RTS RADIO CONTROL

Individual control with Telis transmitter or/and wall switch  
(Glydea™ DCT motor + RTS 433 receiver)

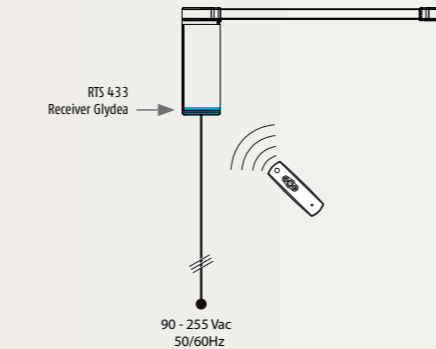

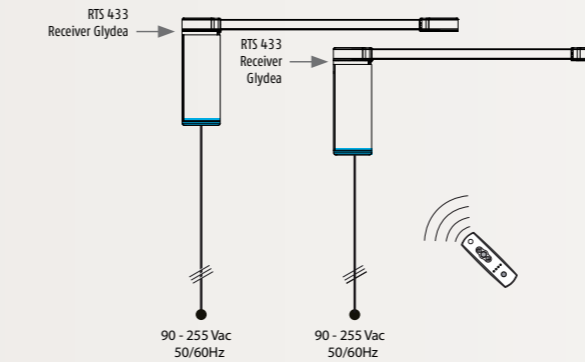

Group and individual control with 4 channels Telis transmitter  
(Glydea™ DCT motors + RTS 433 receiver)





RTS 433 receiver Glydea™	
	Plug-in 433 Mhz RTS receiver
	Compatible with Glydea™ 35 DCT and Glydea™ 60e DCT
	Unit:
	Ref. 1 870172
	Price:

Smoove 1 open/close RTS			
	One channel sensitive wall switch (frames to be ordered separately)		
	Unit: 1		
	Pure Shine	Ref. 1 811 011	Price:
	Black Shine	Ref. 1 810 009	Price:

Wall switch frames			
	Frames to be used with Smoove RTS wall switch		
	Pure	Ref. 9 015 022	Price:
	Silver Lounge	Ref. 9 015 024	Price:
	Silver Mat	Ref. 9 015 025	Price:
	Black	Ref. 9 015 023	Price:
	Light Bamboo	Ref. 9 015 027	Price:
	Amber Bamboo	Ref. 9 015 026	Price:
	Cherry	Ref. 9 015 036	Price:
	Walnut	Ref. 9 015 037	Price:

Telis 1 RTS			
	One channel RTS transmitter		
	Unit: 1		
	Pure	Ref. 1 810 630	Price:
	Patio	Ref. 1 810 642	Price:
	Silver	Ref. 1 810 637	Price:
	Lounge	Ref. 1 810 649	Price:

Telis 4 RTS			
	Five channels RTS transmitter		
	Unit: 1		
	Pure	Ref. 1 810 631	Price:
	Patio	Ref. 1 810 644	Price:
	Silver	Ref. 1 810 638	Price:
	Lounge	Ref. 1 810 651	Price:

Chronis RTS			
	One channel RTS timer		
	Unit: 1		
	Chronis Easy RTS	Ref. 1 805 126	Price:
	Chronis RTS Light	Ref. 1 805 055	Price:

ThermoSunis indoor wireFree™ RTS			
	Indoor battery powered RTS sun sensor		
	Unit: 1		
	Ref. 9013708		
	Price:		

All information subject to change without prior notice.

## 2 GLYDEA™ DCT MOTORS WIRED AND INFRARED CONTROL

### Infrared individual control with IR3 sensor and IR1

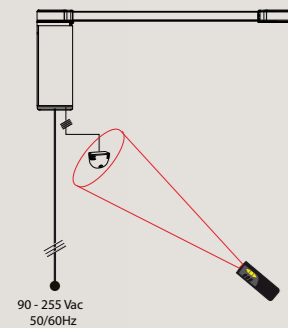

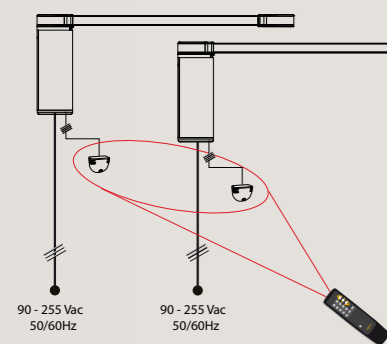

### Infrared group control with IR3 sensor and IR8



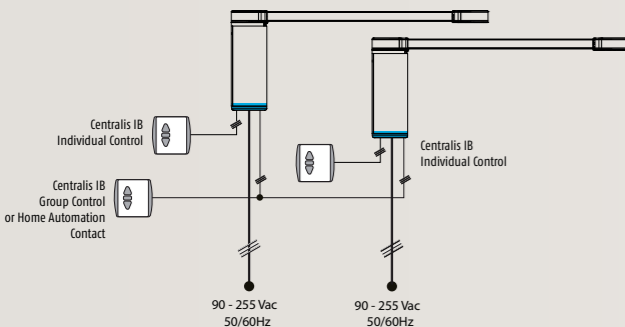

### DCT individual and/or group control with centralis IB using Glydea™ DCT splitter





<b>IR1</b>		Infrared One Channel transmitter Unit: 1 Packaging: 10 Ref. 1 870 133 Price:
------------	---	--

<b>IR8</b>		Infrared Eight Channels transmitter Unit: 1 Packaging: 10 Ref. 1 870 132 Price:
------------	---	---

<b>IR3 ILT sensor</b>		Infrared sensor, compatible with Somfy IR1 & IR8, and all Universal IR transmitter To be used with RJ9/RJ12 adapter Ref. 9 014 068 Unit: 1 Packaging: 10 Ref. 9 154 205 Price:
-----------------------	---	---

<b>DCT splitter Glydea</b>		Unit equipped with 2 RJ12, screw terminal blocks and diodes. Used for individual, group and master control with 2 Normally Open dry contact switches or IR Unit: 1 Packaging: 12 Ref. 9 015 442 Price:
----------------------------	---	--

<b>Centralis IB</b>		2 Normally Open Contact + Stop in parallel, to be used for individual, group DCT control Unit: 1 Packaging: Ref. 1 810 138 Price:
---------------------	--	---

<b>Cable DCT 2.5m</b>		Cable equipped with a RJ 12 connector Unit: 1 Packaging: 10 Ref. 9 015 443 Price:
-----------------------	---	---

• Glydea™ DCT motors are compatible with Home Automation Dry Contact System and Universal Infrared transmitter.

## 3 GLYDEA™ WT MOTOR WIRED CONTROL

### Individual or group control with AC switch

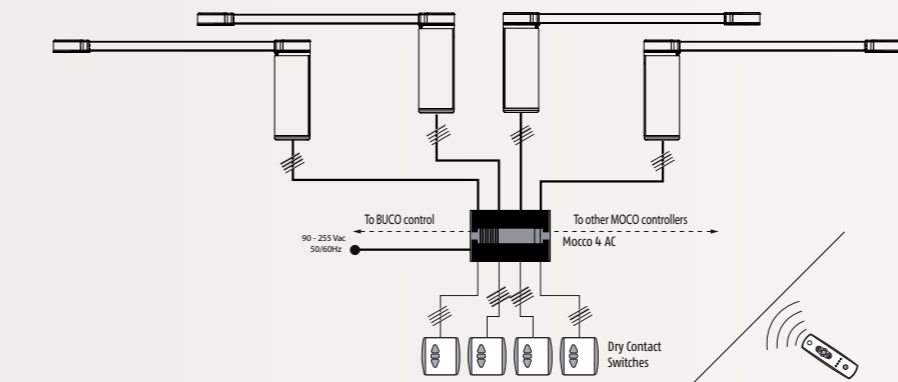
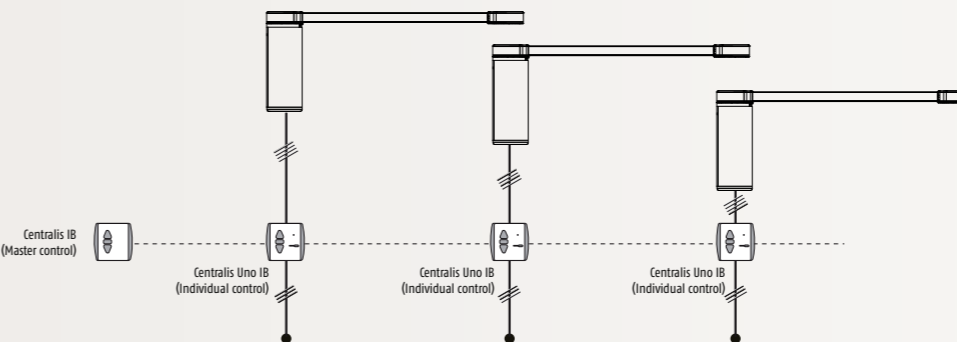
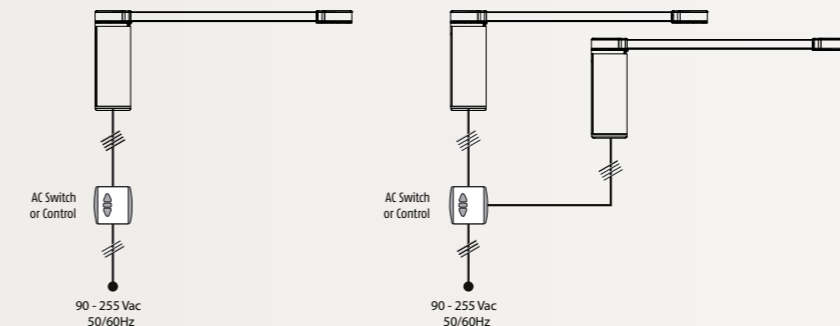

<b>Inis uno inteo PF</b>		Individual control maintained switch Unit: 1 Ref. 1 800 016 Price:
--------------------------	---	---

<b>Série espace PF</b>		Individual control maintained switch Unit: 1 Ref. 1 800 154 Price:
------------------------	---	---

<b>Centralis uno IB</b>		Individual AC control with master control bus connection Unit: 1 Ref. 1 810 209 Price:
-------------------------	---	---

<b>Centralis IB</b>		Dry contact switch for bus master control Unit: 1 Ref. 1 810 138 Price:
---------------------	---	--

<b>Chronis IB</b>		Timer for master bus line control Unit: 1 Ref. 1 805 024 Price:
-------------------	---	--

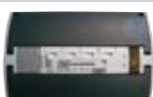
<b>Motor controller 4AC-230VAC</b>		Individual and master control by animeo Unit: 1 Ref. 1 860 049 Price:
------------------------------------	---	--

<b>Motor controller 4AC RTS 433</b>		Individual control by animeo and RTS transmitter Master control by animeo Unit: 1 Ref. 1 860 109 Price:
-------------------------------------	---	---

All information subject to change without prior notice. June 2010 preliminary version - 21

## Part list

### Motors & Controls

	<b>Glydea™ 35 DCT EU 1.5 m</b>	
	Unit: 1	Packaging: 8
	Ref. 1 001 261	
	Price:	
	<b>Glydea™ 35 WT EU 1.5M</b>	
	Unit: 1	Packaging: 8
	Ref. 1 001 525	
	Price:	
	<b>Glydea™ 60e DCT EU 1.5M</b>	
	Unit: 1	Packaging: 8
	Ref. 1 001 265	
	Price:	
	<b>Glydea™ 60e WT EU 1.5M</b>	
	Unit: 1	Packaging: 8
	Ref. 1 001 537	
	Price:	

	<b>RTS 433 receiver Glydea™</b>	
	Unit: 1	Packaging: 24
	Ref. 1 870 172	
	Price:	

	<b>DCT splitter Glydea™</b>	
	Unit: 1	Packaging: 12
	Ref. 9 015 442	
	Price:	

### Track components

	<b>Pulley GA</b>	
	Pulley assembly to put opposite the motor side with bush bearing	
	Unit: 1	Packaging: 10
	Ref. 1 780 897	
Price:		

	<b>Drive pulley GA</b>	
	Pulley assembly to use on the motor side with bush bearing	
	Unit: 1	Packaging: 10
	Ref. 1 780 945	
Price:		

	<b>Motor bottom cover GA</b>	
	Motor bottom cover spare part	
	Unit: 1	Packaging: 10
	Ref. 9 015 579	
Price:		

	<b>Rail 16' / 5 m by 6 GA</b>	
	16' / 5 m long Glydea track aluminium profile	
	Unit: 1 rail	Packaging: 6 / 4
	Ref. 1 780 899 / 1 781 379	
Price:		

	<b>Rail joint GA</b>	
	To link two rails	
	Unit: 1	Packaging: 10
	Ref. 1 780 891	
Price:		

	<b>Motor hook GA for classic curtain</b>	
	Minimum one for 1-way and two for 2-way	
	Unit: 1	Packaging: 20
	Ref. 1 780 895	
Price:		

	<b>Pulley cover GA</b>	
	Pulley cover spare part	
	Unit: 1	Packaging: 10
	Ref. 1 780 898	
Price:		

	<b>Pulley stopper assembly GA</b>	
	Spare pulley stopper assembly as a kit	
	Unit: 1	Packaging: 10
	Ref. 1 780 954	
Price:		

	<b>Swivel ceiling bracket GA</b>	
	Ceiling bracket to minimize the light gap (max 2 mm)	
	Unit: 1	Packaging: 100
	Ref. 1 780 906	
Price:		

	<b>One touch ceiling bracket GA</b>	
	For easy installation	
	Unit: 1	Packaging: 100
	Ref. 1 780 907	
Price:		

	<b>Adjustable wall mount bracket GA</b>	
	Bracket with minimum 100 mm projection and 34 mm extension, to use with swivel or one touch ceiling bracket	
	Unit: 1	Packaging: 1
	Ref. 1 780 909	
Price:		

	<b>Double adjustable wall mount Bracket GA GA</b>	
	Wall bracket to mount 2 rails equipped with swivel or one touch ceiling bracket. 200 mm projection, 27 mm extension and 100 mm between rails.	
	Unit: 1	Packaging: 1
	Ref. 1 780 910	
Price:		

	<b>10 mm belt 100m roll GA</b>	
	T5 timing belt with 5 steel core tension cord, with textile on the back and the tooth	
	Unit: 1 roll	Packaging: 100 m
	Ref. 1 780 900	
Price:		

	<b>Cushion for belt GA</b>	
	Rubber part to be positioned in the assembled track to prevent the belt off splitted track transported folded	
	Unit: 1	Packaging: 100
	Ref. 1 780 955	
Price:		

### Accessories for "classic" curtain with flexible master carrier

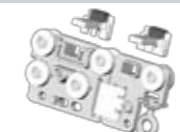
	<b>Master carrier GA 35</b>	
	Maximum load 35 kg for 6 m track	
	Unit: 1	Packaging: 10
	Ref. 1 780 890	
Price:		

	<b>Straight arm GA 35</b>	
	Unit: 1	Packaging: 10
	Ref. 1 780 894	
Price:		

	<b>Overlap arm GA 35</b>	
	Unit: 1	Packaging: 10
	Ref. 1 780 893	
Price:		

	<b>Rotating eye runner GA</b>	
	1.5 kg maximum load	
	Unit: 1	Packaging: 500
	Ref. 1 780 892	
Price:		

### Accessories for "classic" curtain with heavy duty master carrier

	<b>Heavy duty master carrier GA</b>	
	Maximum load 35 kg for 6 m track	
	Unit: 1	Packaging: 10
	Ref. 1 781 344	
Price:		

	<b>Heavy duty straight arm GA</b>	
	Stainless steel	
	Unit: 1	Packaging: 100
	Ref. 1 781 4 16	
Price:		

	<b>Heavy duty overlap arm Kit GA</b>	
	Stainless steel with roller	
	Unit: 1	Packaging: 100
	Ref. 1 781 4 17	
Price:		

	<b>High perf rotating eye runner</b>	
	1.5 kg maximum load	
	Unit: 1	Packaging: 500
	Ref. 1 781 415	
Price:		





somfy.com

**Somfy**

50 avenue du Nouveau Monde

BP 152 - 74307 Cluses cedex

France

T +33 (0)4 50 96 70 00

F +33 (0)4 50 96 71 89

**somfy**