

**animeo®**

# Sensor Station Standard Sensor Station Extension

Gebrauchsanweisung  
Installationsvejledning  
Asennusohjeet

Notice d'installation  
Installation guide  
Guida all'installazione

Montagehandleiding  
Installasjonsanvisninger  
Installationsanvisningar

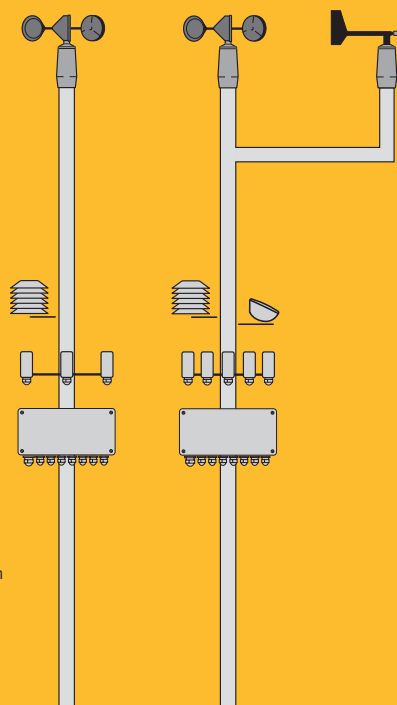

Sensor Station Standard  
Ref. 9013726  
Sensor Station Extension  
Ref. 9013727

[1]

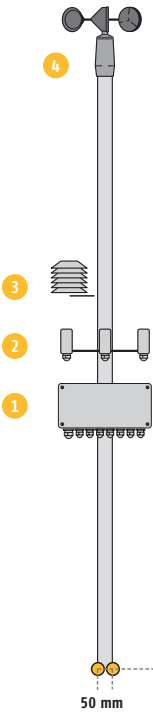

[2]

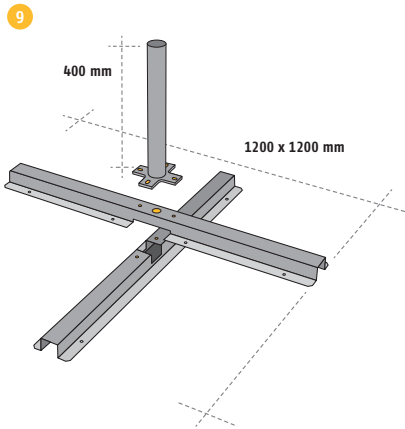
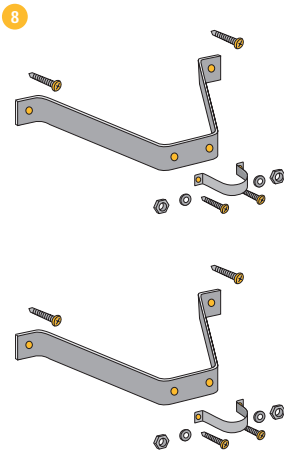
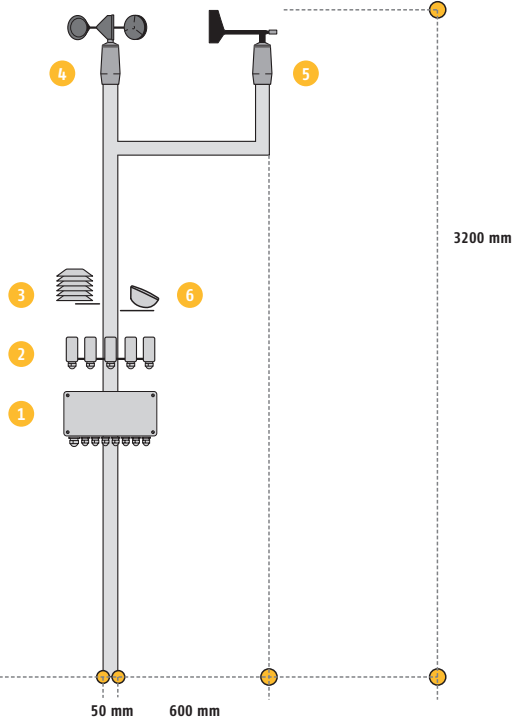

# B

[1]

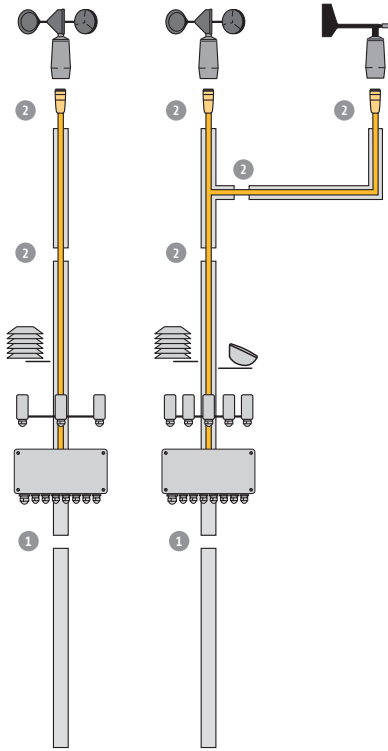

[2]

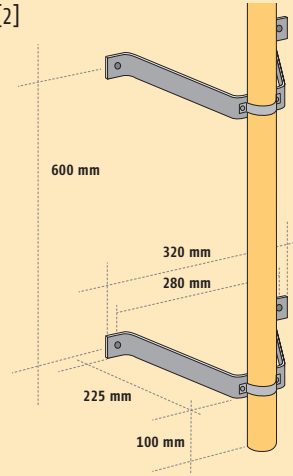

[3]

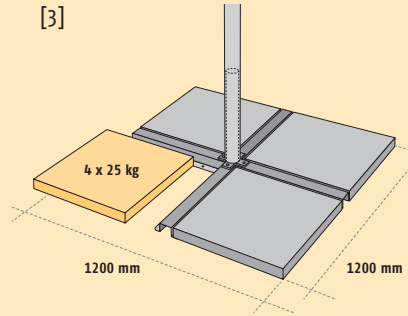

# C

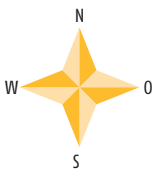

[1]

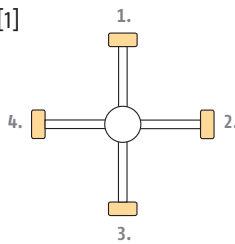

[2]

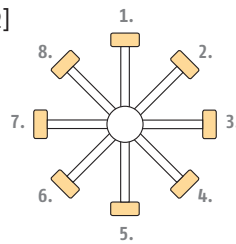

[3]

Outside Sensor Box	1.	2.	3.	4.	5.	6.	7.	8.
Sensor Station Standard	N	O	S	W				
Sensor Station Extension	N	NO	O	SO	S	SW	W	NW

## DE

### A ABBILDUNGEN

- [1] Sensor Station Standard
- [2] Sensor Station Extension
  - 1. Outside Sensor Box
  - 2. Sonnensensor
  - 3. Sensor für Außentemperatur
  - 4. Windsensor
  - 5. Windrichtungssensor
  - 6. Regensensor
  - 7. Befestigungsring für Abspannseil
  - 8. Wandhalterung
  - 9. Standfuß

### B MONTAGE

- [1] Aufbau der Sensor Station:
    - 1. Zusammenstecken
    - 2. Kabel durchziehen und zusammenstecken
- Wahl des richtigen Montageorts mit ausreichendem Platz
- [2] Wandmontage
  - [3] Standmontage/Flachdachmontage

### C AUSRICHTUNG/VERDRAHTUNG

- [1] Sensor Station Standard nach Norden
- [2] Sensor Station Extension nach Norden
- [3] Sonnensensoren verdrahtet auf die Outside Sensor Box

## FI

### A KUVAT

- [1] Sääasema Standard
- [2] Sääasema Extension
  - 1. Ulkosensorikotelo
  - 2. Aurinkosensori
  - 3. Ulkolämpötilasensori
  - 4. Tuulisensori
  - 5. Tuulen suunnan sensori
  - 6. Sadesensori
  - 7. Tukivajjerin kiinnike
  - 8. Seinäkiinnike
  - 9. Kattoasennusjalusta

### B ASENNUS

- [1] Sääaseman kokoonpano:
    - 1. liitos
    - 2. Pujota kaapeli ja aseta osat mastoon
- Valitse soveltuva kiinnitystapa
- [2] Seinäasennus
  - [3] Lattia/kattoasennus

### C ANTURIJÄRJESTYS/KAPELOINTI

- [1] Sääasema Standard pohjoiseen
- [2] Sääasema Extension pohjoiseen
- [3] Aurinkosensorien kytkentäjärjestys ulkosensorikoteloon

## FR

### A IMAGES

- [1] Station météo standard
- [2] Station météo extension
  - 1. Boîtier capteur extérieur
  - 2. Capteur solaires
  - 3. Capteur de température extérieur
  - 4. Capteur vent
  - 5. Capteur direction vent
  - 6. Capteur pluie
  - 7. Accessoire fixation hauban
  - 8. Accessoire montage mural
  - 9. Pied de fixation

### B MONTAGE

- [1] Montage de la station météo:
    - 1. Câblage
    - 2. Paire passer le câble et assembler les différentes parties du mât
- Choisir le meilleur emplacement avec espace suffisant
- [2] Fixation murale
  - [3] Montage au sol

### C ORIENTATION/CÂBLAGE

- [1] Station météo standard  
Comment positionner les capteurs/nord
- [2] Station météo extension  
Comment positionner les capteurs/nord
- [3] Câblage capteurs sur boîtiers

## GB

### A PICTURES

- [1] Sensor Station Standard
- [2] Sensor Station Extension
  - 1. Outside Sensor Box
  - 2. Sun sensor
  - 3. Outside temperature sensor
  - 4. Wind sensor
  - 5. Wind direction sensor
  - 6. Rain sensor
  - 7. Strain connection for guy wire
  - 8. Wall mounted bracket
  - 9. Pedestal for roof mounting

### B MOUNTING

- [1] Construction of the sensor station:
    - 1. Connection
    - 2. Pull through cable and assemble the parts of the mast
- Choose the optimal location with sufficient area
- [2] Wall fixing
  - [3] Floor mounting/Flat roof mounting

### C ALIGNMENT/WIRING

- [1] Sensor Station Standard to the North
- [2] Sensor Station Extension to the North
- [3] Sun sensors wired up on the Outside Sensor Box

## IT

### A DESCRIZIONE DEL PRODOTTO

- [1] Stazione sensori standard
- [2] Estensione per stazione sensori
  - 1. Interfaccia sensori esterni
  - 2. Sensore solare
  - 3. Sensore di temperatura esterna
  - 4. Sensore del vento
  - 5. Sensore direzione vento
  - 6. Sensore della pioggia
  - 7. Raccordo
  - 8. Supporto montaggio a muro
  - 9. Staffa per fissaggio per tetti

### B MONTAGGIO

- [1] Assemblaggio stazione sensori:
    - 1. Cablaggio centralina
    - 2. Inserimento del cablaggio e assemblaggio palo di sostegno
- Scegliere il luogo più adatto per il montaggio
- [2] Fissaggio a muro
  - [3] Base di montaggio per fissaggio su tetto

### C ORIENTAMENTO/CABLAGGIO

- [1] Stazione sensori standard a nord
- [2] Estensione per stazione sensori a nord
- [3] Sensore solare collegato all'interfaccia sensori esterni

## NL

### A AFBEELDING

- [1] Standaard weerstation
- [2] Uitgebreid weerstation
  - 1. Outside Sensor Box
  - 2. Zonnecel
  - 3. Buitentemperatuursensor
  - 4. Windpulsgenerator
  - 5. Windrichting meter
  - 6. Regensensor
  - 7. Klem voor bevestiging van tui draden
  - 8. Muurbeugels
  - 9. Montagevoet voor bevestiging op het dak

### B MONTAGE

- [1] Schema van het weerstation:
    - 1. Montage muurbeugels
    - 2. Voer de kabels door en stel de mast samen
- Kies de juiste plaats met voldoende ruimte
- [2] Muur bevestiging
  - [3] Vloer montage/Plat dak montage

### C UITLIJNEN/BEDRADING

- [1] Standaard weerstation naar het Noorden richten
- [2] Uitgebreid weerstation naar het Noorden richten
- [3] Aansluitvolgorde van de zonnecellen in de Outside Sensor Box

## NO

### A BILDER

- [1] Sensor Station Standard
- [2] Sensor Station Extension
  - 1. Outside Sensor Box
  - 2. Sol sensor
  - 3. Utendørs temperatur sensor
  - 4. Vind sensor
  - 5. Vind retning sensor
  - 6. Regnsensor
  - 7. Feste for sikkerhets wire
  - 8. Vegg brakett
  - 9. Brakett for tak montering

### B MONTERING

- [1] Konstruksjon av sensor station:
    - 1. Tilkobling
    - 2. Trekk inn kabler og monter deler av masten
- Velg riktig plassering og god plass
- [2] Veggmontering
  - [3] Gulv montering/Flatt tak montering

### C ALLOKERING/KABLING

- [1] Sensor Station Standard til Nord
- [2] Sensor Station Extension til Nord
- [3] Sol sensor kablet opp til Outside Sensor Box

## SE

### A BILDER

- [1] Sensor Station Standard
- [2] Sensor Station Extension
  - 1. Sensorbox utomhus
  - 2. Solsensor
  - 3. Temp.sensor ute
  - 4. Vindsensor
  - 5. Vindriktningsgivare
  - 6. Regnsensor
  - 7. Montagekrage för stödvajrar
  - 8. Väggekonsoler
  - 9. Takfäste

### B INSTALLATION









- [1] Sensorstationens konstruktion:
    - 1. Anslutning
    - 2. Dra kablar genom rören och montera ihop masten
- Välj lämplig placering med fri vind och utan skugga under dagen.
- [2] Väggmontage
  - [3] Takmontage

### C ORIENTERING/KABLAGE

- Montera mastens sol och vindriktningssensorer i korrekt kompassriktning.
- [1] Sensor Station Standard mot norr
  - [2] Sensor Station Extension mot norr
  - [3] Solsensorennas montering och anslutning i sensorboxen

## Accessories

www.somfy.com/ce

Ref.	Article	Pictures	Sensor Station Standard	Sensor Station Extension	
1	9001606	Outside Sensor Box		1	1
2	9050100	Sun Sensor		4	8
3	9001608	Wind Sensor not heated		1	1
4	9013807	Wind Direction Sensor		-	1
5	9016334	Rain Sensor Ondeis 24 V DC		-	1
6	9001611	Outside Temperature Sensor		1	1
7	9014303	Strain connection for roof mounting		Optional	Optional
8	9001636	Wall mounted bracket		1	1
9	9014300	Roof mounting		Optional	Optional

Notes

- DE** Vor Inbetriebnahme unbedingt die Sicherheitsanweisungen in dieser Anleitung beachten. Die Haftung von SOMFY für Mängel und Schäden ist ausgeschlossen, wenn diese auf Nichtbeachten der Gebrauchsanweisung (falsche Installation, Fehlbedienung, etc.) beruhen. Errichten, Prüfen und Inbetriebsetzen der Anlage darf nur von einer Fachkraft (lt. VDE 0100) durchgeführt werden! Schalten Sie alle zu montierenden Anschlussleitungen spannungslos! Treffen Sie Vorkehrungen gegen unbeabsichtigtes Einschalten!
- DK** Før installationen påbegyndes, skal denne vejledning læses, og anvisningerne følges. Fejl på installationen kan medføre alvorlig personskade. Produktet skal monteres af en autoriseret elektriker. Somfy's ansvar for mangler og skader, bortfalder hvis anvisningerne i denne installationsvejledning ikke følges. Gem denne vejledning til fremtidigt brug.
- FI** Ennen asennusta, ole hyvä ja lue ja seuraa näitä ohjeita. Virheellinen asennus voi aiheuttaa vakavia vaurioita. Tuotteen tulee asentaa valtuutettu sähköasentaja. SOMFY:n vastuu virheistä ja vaurioista poistuu, jos ne ovat aiheutuneet ohjeiden vastaisesta toiminnasta. Säilytä nämä ohjeet.
- FR** Avant la mise en œuvre, veuillez lire et suivre les instructions de sécurité ci-jointes. Une mauvaise installation peut conduire à de graves blessures. Le produit doit être installé par un électricien qualifié. SOMFY ne peut être tenue responsable des vices et des dommages occasionnés par un non respect de ces instructions. Conservez ces instructions pour toute intervention sur le produit.
- GB** Before installation, please read and follow these instructions. An incorrect installation could lead to serious injury. The product must be installed by a qualified electrician. SOMFY's liability for defects and damages is excluded if they were caused by disregard of the instructions. Keep these instructions for future reference.
- IT** Prima dell'installazione leggere attentamente queste istruzioni. Un'installazione non corretta può causare gravi ferite. L'installazione deve essere eseguita da un elettricista qualificato. SOMFY non può essere ritenuta responsabile per difetti o danneggiamenti causati dal mancato rispetto di queste istruzioni. Conservare queste istruzioni.
- NL** Lees voor het installeren eerst deze handleiding. Een onjuiste installatie kan de apparatuur ernstig beschadigen. Dit product mag alleen door een deskundige aangesloten worden. De SOMFY garantie is niet van toepassing als de aanwijzigingen in deze handleiding genegeerd worden. Bewaar dit document voor later gebruik.
- NO** Før installasjon, les disse instruksjer. Feil installasjon kan føre til alvorlig skade. Installasjonen skal utføres av autorisert installatør. SOMFY's ansvar for skader bortfaller hvis disse instruksjoner ikke følges. Behold instruksjonene for fremtidige referanser.
- SE** Före installation, läs noggrant igenom denna manual och följ sedan instruktionerna. En felaktig installation kan medföra livsfara. Produkten skall installeras av behörig elektriker. SOMFY's åtaganden gäller ej om installation inte utförts enligt instruktionerna. Spara manualen för framtida bruk.

Notes

AUSTRIA  
**SOMFY GesmbH**  
[www.somfy.at](http://www.somfy.at)  
Tel.: +43 (0) 662 625 308

AUSTRALIA  
**SOMFY Pty Limited**  
[www.somfy.com.au](http://www.somfy.com.au)  
Tel.: +61 (0) 296 380 744

BELGIUM  
**SOMFY NV SA**  
[www.somfy.be](http://www.somfy.be)  
Tel.: +32 (0) 27 120 770

BRASIL  
**SOMFY BRASIL Ltda**  
[www.somfy.com.br](http://www.somfy.com.br)  
Tel.: +55 (0) 1 136 953 585

CANADA  
**SOMFY ULC**  
[www.somfysystems.com](http://www.somfysystems.com)  
Tel.: +1 (0) 9 055 646 446

CHINA  
**SOMFY China Co Ltd.**  
[www.somfy.com.cn](http://www.somfy.com.cn)  
Tel.: +86 (0) 2 162 809 660

CYPRUS  
**SOMFY Middle East Co. Ltd.**  
[www.somfy.com](http://www.somfy.com)  
Tel.: +357 (0) 25 345 540

CZECH REPUBLIC  
**SOMFY Spol s.r.o**  
[www.somfy.cz](http://www.somfy.cz)  
Tel.: +420 (0) 2 963 724 867

DENMARK  
**SOMFY Nordic AB**  
[www.somfy.dk](http://www.somfy.dk)  
Tel.: +45 (0) 65 325 793

FINLAND  
**SOMFY Nordic AB**  
[www.somfy.fi](http://www.somfy.fi)  
Tel.: +358 (0) 957 130 230

FRANCE  
**SOMFY France**  
[www.somfy.fr](http://www.somfy.fr)  
Tel.: +33 (0) 450 967 096

GERMANY  
**SOMFY GmbH**  
[www.somfy.de](http://www.somfy.de)  
Tel.: +49 (0) 74 729 300

GREECE  
**SOMFY Hellas SA**  
[www.somfy.com](http://www.somfy.com)  
Tel.: +30 (0) 2 106 146 768

HONG KONG  
**SOMFY Co. Ltd.**  
[www.somfy.cn](http://www.somfy.cn)  
Tel.: +852 (0) 25 236 339

HUNGARY  
**SOMFY Kft**  
[www.somfy.hu](http://www.somfy.hu)  
Tel.: +36 (0) 18 145 120

INDIA  
**SOMFY India Private Limited**  
[www.somfy.co.in](http://www.somfy.co.in)  
Tel.: +91 (0) 1 146 111 555

ISRAEL  
**SISA HOME AUTOMATION LTD**  
[www.somfy.co.il](http://www.somfy.co.il)  
Tel.: +972 (0) 39 525 554

ITALY  
**SOMFY Italia S.R.L**  
[www.somfy.it](http://www.somfy.it)  
Tel.: +39 (0) 24 847 181

JAPAN  
**SOMFY K.K**  
[www.somfy.co.jp](http://www.somfy.co.jp)  
Tel.: +81 (0) 454 750 732

KOREA  
**SOMFY JOO**  
[www.somfy.co.kr](http://www.somfy.co.kr)  
Tel.: +82 (0) 316 005 250

KUWAIT  
**SOMFY Kuwait**  
[www.somfy.com](http://www.somfy.com)  
Tel.: +965 (0) 9 889 467

LEBANON  
**SOMFY Lebanon**  
[www.somfy.com.lb](http://www.somfy.com.lb)  
Tel.: +961 (0) 1 427 888

MEXICO  
**SOMFY MEXICO SA de CD**  
[www.somfy.mx](http://www.somfy.mx)  
Tel.: +52 (0) 55 477 777 701

NETHERLANDS  
**SOMFY Nederland B.V**  
[www.somfy.nl](http://www.somfy.nl)  
Tel.: +31 (0) 235 544 900

NORWAY  
**SOMFY Nordic AB**  
[www.somfy.no](http://www.somfy.no)  
Tel.: +47 (0) 41 576 639

POLAND  
**SOMFY SP Z.O.O**  
[www.somfy.pl](http://www.somfy.pl)  
Tel.: +48 (0) 225 095 300

PORTUGAL  
**SOMFY Portugal**  
[www.somfy.pt](http://www.somfy.pt)  
Tel.: +351 (0) 229 396 840

RUSSIA  
**SOMFY LLC**  
[www.somfy.ru](http://www.somfy.ru)  
Tel.: +7 (0) 953 604 186

SINGAPORE  
**SOMFY PTE LTD**  
[www.somfy.com.sg](http://www.somfy.com.sg)  
Tel.: +65 (0) 63 833 855

SPAIN  
**SOMFY Espana SA**  
[www.somfy.es](http://www.somfy.es)  
Tel.: +34 (0) 934 800 900

SWEDEN  
**SOMFY Nordic AB**  
[www.somfy.se](http://www.somfy.se)  
Tel.: +46 (0) 40 165 900

SWITZERLAND  
**SOMFY AG**  
[www.somfy.ch](http://www.somfy.ch)  
Tel.: +41 (0) 18 384 030

TAIWAN  
**SOMFY Development  
Taiwan Branch**  
[www.somfy.com.tw](http://www.somfy.com.tw)  
Tel.: +886 (0) 226 587 150

TURKEY  
**SOMFY Turkiye**  
[www.somfy.com.tr](http://www.somfy.com.tr)  
Tel.: +90 (0) 2 166 513 015

UNITED KINGDOM  
**SOMFY Ltd.**  
[www.somfy.co.uk](http://www.somfy.co.uk)  
Tel.: +44 (0) 1 133 913 030

USA  
**SOMFY Systems Inc.**  
[www.somfysystems.com](http://www.somfysystems.com)  
Tel.: +1 (0) 6 093 951 300